



# Dell™ Inspiron™ 1525/1526 Service Manual

[Before You Begin](#)  
[Subscriber Identity Module \(Optional\)](#)  
[ExpressCards](#)  
[Using the Memory Card Reader](#)  
[Optical Drive](#)  
[Hard Drive](#)  
[Center Control Cover](#)  
[Internal Card With Bluetooth® Wireless Technology](#)  
[Keyboard](#)  
[Button Board](#)  
[Memory](#)  
[Display](#)

[Speaker Assembly](#)  
[Palm Rest](#)  
[ExpressCard Cage](#)  
[Processor Thermal-Cooling Assembly](#)  
[Processor Module](#)  
[Wireless Mini-Cards](#)  
[System Board Assembly](#)  
[Coin-Cell Battery](#)  
[Battery Latch Assembly](#)  
[Flashing the BIOS](#)  
[Pin Assignments for I/O Connectors](#)

---

## Notes, Notices, and Cautions

-  **NOTE:** A NOTE indicates important information that helps you make better use of your computer.
-  **NOTICE:** A NOTICE indicates either potential damage to hardware or loss of data and tells you how to avoid the problem.
-  **CAUTION:** A CAUTION indicates potential for property damage, personal injury, or death.

---

Information in this document is subject to change without notice.  
© 2007–2008 Dell Inc. All rights reserved.

Reproduction in any manner whatsoever without the written permission of Dell Inc. is strictly forbidden.

Trademarks used in this text: *Dell*, the *DELL* logo, and *Inspiron* are trademarks of Dell Inc.; *Microsoft*, *Windows*, and *Windows Vista* are either trademarks or registered trademarks of Microsoft Corporation in the United States and/or other countries.

Other trademarks and trade names may be used in this document to refer to either the entities claiming the marks and names or their products. Dell Inc. disclaims any proprietary interest in trademarks and trade names other than its own.

Model PP29L

January 2008 Rev. A00

[Back to Contents Page](#)

## Before You Begin

### Dell™ Inspiron™ 1525/1526 Service Manual

- [Recommended Tools](#)
- [Before Working Inside Your Computer](#)

This document provides procedures for removing and installing the components in your computer. Unless otherwise noted, each procedure assumes that:

- 1 You have performed the steps in [Before Working Inside Your Computer](#).
- 1 You have read the safety information in your Dell *Product Information Guide*.
- 1 When replacing a component, you have already removed the original, if installed.

 **NOTE:** The color of your system and certain system components may appear differently than shown in this document.

---

## Recommended Tools

The procedures in this document may require the following tools:

- 1 Small flat-blade screwdriver
  - 1 Phillips screwdriver
  - 1 Small plastic scribe
  - 1 Flash BIOS update (see the Dell Support website at [support.dell.com](http://support.dell.com))
- 

## Before Working Inside Your Computer

Use the following safety guidelines to help protect your computer from potential damage and to help ensure your own personal safety.



 **CAUTION:** Before you begin any of the procedures in this section, follow the safety instructions in the *Product Information Guide*.

 **NOTICE:** Only a certified service technician should perform repairs on your computer. Damage due to servicing that is not authorized by Dell is not covered by your warranty.

 **NOTICE:** To avoid electrostatic discharge, ground yourself by using a wrist grounding strap or by periodically touching an unpainted metal surface, such as a connector on the back of the computer.

 **NOTICE:** Handle components and cards with care. Do not touch the components or contacts on a card. Hold a card by its edges or by its metal mounting bracket. Hold a component such as a processor by its edges, not by its pins.

 **NOTICE:** When disconnecting a cable, pull on the cable's connector or on its strain-relief loop, not on the cable itself. For cable connectors with locking tabs, press inward on the locking tabs to release the connector. When connecting a cable, ensure that the connectors are correctly oriented and aligned to avoid damage to the connector and/or the connector's pins.

1. Ensure that the work surface is flat and clean to prevent the computer cover from being scratched.
2. Click **Start** , click the arrow  icon, and then click **Shut Down** to turn off your computer.

 **NOTE:** Ensure that the computer is off and not in a power management mode. If you cannot shut down the computer using the operating system, press and hold the power button for 4 seconds.

3. Disconnect your computer and all attached devices from their electrical outlets.

 **NOTICE:** To disconnect a network cable, first unplug the cable from your computer, and then unplug it from the network wall jack.

4. Disconnect any telephone or network cables from the computer.

5. Remove any installed cards from the ExpressCard slot (see [Removing an ExpressCard or Blank](#)) and the 8-in-1 memory card reader (see [Removing a Memory Card or Blank](#)).

 **NOTICE:** To help prevent damage to the system board, you must remove the battery from the battery bay before you service the computer.

 **NOTE:** To avoid damage to the computer, use only the battery designed for this particular Dell computer. Do not use batteries designed for other Dell computers.

6. Turn the computer over.

7. Slide the battery release latch until they click into place.

8. Slide the battery out of the battery bay.

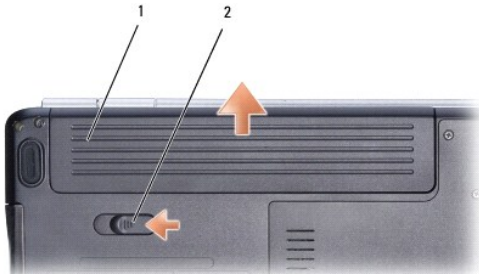

1	battery	2	battery release latch
---	---------	---	-----------------------

9. Turn the computer top-side up, open the display, and press the power button to ground the system board.

---

[Back to Contents Page](#)

## Flashing the BIOS

### Dell™ Inspiron™ 1525/1526 Service Manual

- [Flashing the BIOS From a CD](#)
- [Flashing the BIOS From the Hard Drive](#)

If a BIOS-update program CD is provided with a new system board, flash the BIOS from the CD. If you do not have a BIOS-update program CD, flash the BIOS from the hard drive.

---

## Flashing the BIOS From a CD

➡ **NOTICE:** Plug the AC adapter into a known good power source to prevent a loss of power. Failure to do so may cause system damage.

1. Ensure that the AC adapter is plugged in and that the main battery is installed properly.

📌 **NOTE:** If you use a BIOS update program CD to flash the BIOS, press <F12> before inserting the CD so that you can set up the computer to boot from a CD for one time only. Otherwise, you must enter the system setup program to change the default boot order.

2. Insert the BIOS-update program CD, and turn on the computer.

➡ **NOTICE:** Do not interrupt this process once it begins. Doing so may cause system damage.

Follow the instructions that appear on the screen. The computer continues to boot and updates the new BIOS. When the flash update is complete, the computer will automatically reboot.

3. Press <F2> during POST to enter the system setup program.
  4. Press <Alt> and <f> to reset the computer defaults.
  5. Press <Esc>, select **Save/Exit**, and press <Enter> to save configuration changes.
  6. Remove the flash BIOS update program CD from the drive and restart the computer.
- 

## Flashing the BIOS From the Hard Drive

➡ **NOTICE:** Plug the AC adapter into a known good power source to prevent a loss of power. Failure to do so may cause system damage.

1. Ensure that the AC adapter is plugged in, the main battery is properly installed, and a network cable is attached.
2. Turn on the computer.
3. Locate the latest BIOS update file for your computer at [support.dell.com](http://support.dell.com).

4. Click **Download Now** to download the file.

5. If the **Export Compliance Disclaimer** window appears, click **Yes, I Accept this Agreement**.

The **File Download** window appears.

6. Click **Save this program to disk**, and then click **OK**.

The **Save In** window appears.

7. Click the down arrow to view the **Save In** menu, select **Desktop**, and then click **Save**.

The file downloads to your desktop.

8. Click **Close** if the **Download Complete** window appears.

The file icon appears on your desktop and is titled the same as the downloaded BIOS update file.



9. Double-click the file icon on the desktop and follow the instructions on the screen.

---

[Back to Contents Page](#)

## Internal Card With Bluetooth® Wireless Technology

### Dell™ Inspiron™ 1525/1526 Service Manual

-  **CAUTION:** Before you begin any of the procedures in this section, follow the safety instructions in the *Product Information Guide*.
-  **NOTICE:** To avoid electrostatic discharge, ground yourself by using a wrist grounding strap or by periodically touching an unpainted metal surface (such as a connector on the back of the computer).
-  **NOTICE:** To help prevent damage to the system board, you must remove the battery from the battery bay before you begin working inside the computer.

## Removing the Internal Card With Bluetooth® Wireless Technology

1. Follow the procedures in [Before You Begin](#).
2. Remove the center control cover (see [Removing the Center Control Cover](#)).
3. Remove the screw securing the card.
4. Grasp the connector end of the card and slide it out from under the securing tabs.
5. Disconnect the cable from the card.

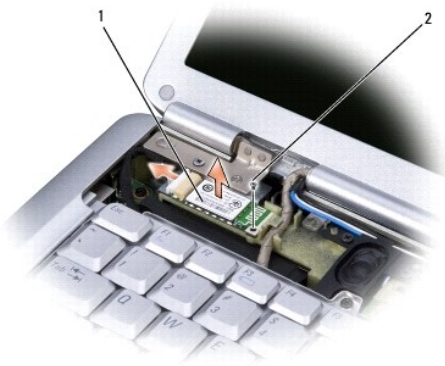



1	card	2	securing screw
---	------	---	----------------

## Replacing the Internal Card With Bluetooth® Wireless Technology

1. Connect the cable to the card.
2. Slide the card at an angle into the card compartment and replace the securing screw.
3. Replace the center control cover (see [Replacing the Center Control Cover](#)).

## Button Board

### Dell™ Inspiron™ 1525/1526 Service Manual

-  **CAUTION:** Before you begin any of the procedures in this section, follow the safety instructions in the *Product Information Guide*.
-  **NOTICE:** To avoid electrostatic discharge, ground yourself by using a wrist grounding strap or by periodically touching an unpainted metal surface (such as a connector on the back of the computer).
-  **NOTICE:** To help prevent damage to the system board, you must remove the battery from the battery bay before you begin working inside the computer.

### Removing the Button Board

1. Follow the procedures in [Before You Begin](#).
2. Remove the center control cover (see [Removing the Center Control Cover](#)).
3. Remove the keyboard (see [Removing the Keyboard](#)).
4. Disconnect the button board cable from the system board.
5. Gently pry up the button board from the securing tabs starting from the top left corner.

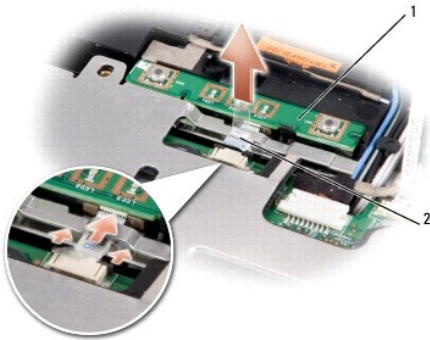

1	button board	2	button board cable
---	--------------	---	--------------------

### Replacing the Button Board

1. To replace the button board, remove the palm rest (see [Removing the Palm Rest](#)).
2. Connect the button board cable to the system board.
3. Place the button board in position and gently press until the button board secures within the tabs.
4. Replace the keyboard (see [Replacing the Keyboard](#)).
5. Replace the center control cover (see [Replacing the Center Control Cover](#)).

## Using the Memory Card Reader

### Dell™ Inspiron™ 1525/1526 Service Manual

### Removing a Memory Card or Blank

**⚠ CAUTION:** Before you begin any of the procedures in this section, follow the safety instructions in the *Product Information Guide*.

**🔄 NOTICE:** Use the memory card configuration utility (click the  icon in the notification area) to select a card and stop it from functioning before you remove it from the computer. If you do not stop the card in the configuration utility, you may lose data.

Press the card into the slot to release it from the card reader. When it is partially ejected, remove the card.

### Installing a Memory Card

**⚠ CAUTION:** Before you begin any of the procedures in this section, follow the safety instructions in the *Product Information Guide*.

You can install a memory card in the computer while the computer is running. The computer automatically detects the card.

Memory cards are generally marked with a symbol (such as a triangle or an arrow) or a label to indicate which end to insert into the slot. The cards are keyed to prevent incorrect insertion. If card orientation is not clear, see the documentation that came with the card.

1. Hold the card with the top side of the card facing up.
2. Slide the card into the slot until the card is completely seated in its connector.

If you encounter too much resistance, do not force the card. Check the card orientation and try again.





The computer recognizes the memory card and automatically loads the appropriate device driver. If the configuration program tells you to load the manufacturer's drivers, use the media that came with the memory card, if applicable.



## Center Control Cover

### Dell™ Inspiron™ 1525/1526 Service Manual

-  **CAUTION:** Before you begin any of the procedures in this section, follow the safety instructions in the *Product Information Guide*.
-  **NOTICE:** To avoid electrostatic discharge, ground yourself by using a wrist grounding strap or by periodically touching an unpainted metal surface (such as a connector on the back of the computer).
-  **NOTICE:** To help prevent damage to the system board, you must remove the battery from the battery bay before you begin working inside the computer.

## Removing the Center Control Cover



1. Follow the procedures in [Before You Begin](#).
2. Remove the two screws securing the center control cover from the battery bay.

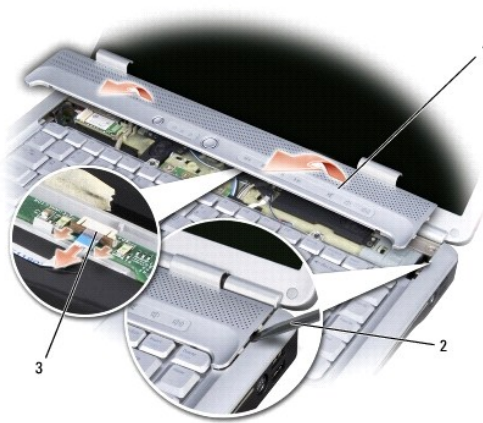

3. Turn the computer top side up, and open the display as far as it will open.
4. Insert a plastic scribe into the indent to lift the center control cover on the right side and ease the center control cover up.



1	center control cover	2	scribe	3	media control buttons connector
---	----------------------	---	--------	---	---------------------------------

5. Disconnect the cable from the media control buttons connector located underneath the center control cover.
-  **NOTICE:** To avoid damage to the data cable connected to the system board, ensure that you do not pull hard when you are raising the center control cover.
  -  **NOTICE:** To avoid damage to the center control cover, do not lift the cover on both sides simultaneously.
6. Remove the center control cover.
  7. Remove the two screws at the top of the keyboard.

**NOTICE:** The key caps on the keyboard are fragile, easily dislodged, and time-consuming to replace. Be careful when removing and handling the keyboard.

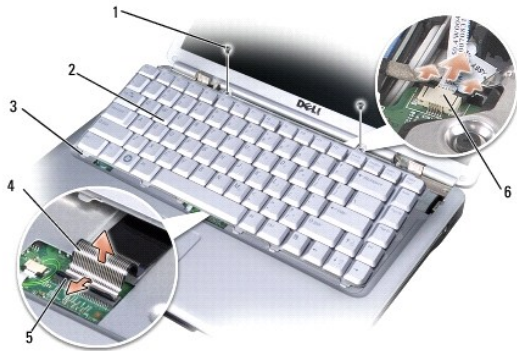

1	screws (2)	2	keyboard
3	keyboard tabs (5)	4	keyboard cable
5	keyboard connector latch	6	media control buttons connector

8. Lift the keyboard and hold it up and slightly forward to access to the media control buttons connector.
9. Disconnect the media control buttons connector and remove the media control buttons cable.

## Replacing the Center Control Cover

1. Reconnect the media control buttons cable to the connector below the keyboard.
2. Align the tabs along the bottom of the keyboard and slide them under the palm rest.
3. Press on the right edge near the top to snap the keyboard into place.
4. Replace the two screws on the top of the keyboard.
5. Reconnect the media control buttons connector to the center control cover.
6. Insert the left edge of the center control cover.
7. Press from left to right until the cover snaps into place.
8. In the battery bay, replace the two screws that secure the center control cover.

---

[Back to Contents Page](#)

## Coin-Cell Battery

### Dell™ Inspiron™ 1525/1526 Service Manual

- [Removing the Coin-Cell Battery](#)
- [Replacing the Coin-Cell Battery](#)

---

## Removing the Coin-Cell Battery

**⚠ CAUTION:** Before you begin any of the procedures in this section, follow the safety instructions in the *Product Information Guide*.

1. Follow the instructions in [Before You Begin](#).
2. Remove all memory module (see [Removing Memory Module](#)).
3. Remove the hard drive (see [Removing the Hard Drive](#)).
4. Remove the optical drive (see [Removing the Optical Drive](#)).
5. Remove all Mini-Cards (see [Removing Mini-Card](#)).
6. Remove the center control cover (see [Removing the Center Control Cover](#)).
7. Remove the keyboard (see [Removing the Keyboard](#)).
8. Remove the display assembly (see [Removing the Display Assembly](#)).
9. Remove the internal card with Bluetooth wireless technology, if installed (see [Removing the Internal Card With Bluetooth® Wireless Technology](#)).
10. Remove the palm rest (see [Removing the Palm Rest](#)).
11. Remove the ExpressCard cage (see [Removing the ExpressCard Cage](#)).
12. Remove the processor thermal-cooling assembly (see [Removing the Processor Thermal-Cooling Assembly](#)).
13. Remove the processor (see [Removing the Processor Module](#)).
14. Remove the system board (see [Removing the System Board Assembly](#)).
15. Use a plastic scribe to pry up the coin-cell battery from the slot.



1	system board	2	slot
3	coin-cell battery		

## Replacing the Coin-Cell Battery

 **CAUTION:** Before you begin the following procedure, follow the safety instructions in the *Product Information Guide*.

1. Hold the coin-cell battery with the positive side up.
  2. Slide the coin-cell battery into the slot and gently press until it snaps to the slot.
  3. Follow the steps in [Removing the Coin-Cell Battery](#) in the reverse order.
- 

[Back to Contents Page](#)

## Processor Module

Dell™ Inspiron™ 1525/1526 Service Manual

### Removing the Processor Module

**CAUTION:** Before you begin the following procedure, follow the safety instructions in the *Product Information Guide*.

1. Follow the instructions in [Before You Begin](#).
2. Remove the processor thermal-cooling assembly (see [Removing the Processor Thermal-Cooling Assembly](#)).

**NOTICE:** To avoid damage to the processor, hold the screwdriver so that it is perpendicular to the processor when turning the cam screw.

3. To loosen the ZIF socket, use a small, flat-blade screwdriver and rotate the ZIF-socket cam screw counterclockwise until it comes to the cam stop.



1	ZIF-socket cam screw	2	ZIF socket
---	----------------------	---	------------

**NOTICE:** To ensure maximum cooling for the processor, do not touch the heat transfer areas on the processor thermal-cooling assembly. The oils in your skin can reduce the heat transfer capability of the thermal pads.

**NOTICE:** When removing the processor module, pull the module straight up. Be careful not to bend the pins on the processor module.

4. Lift the processor module from the ZIF socket.

### Replacing the Processor Module

**CAUTION:** Before you begin the following procedure, follow the safety instructions in the *Product Information Guide*.

**NOTICE:** Do not touch the processor die. Press and hold the processor down on the substrate on which the die is mounted while turning the cam screw to prevent intermittent contact between the cam screw and processor.

**NOTICE:** Ensure that the cam lock is in the fully open position before seating the processor module. Seating the processor module properly in the ZIF socket does not require force. A processor module that is not properly seated can result in an intermittent connection or permanent damage to the microprocessor and ZIF socket.

**NOTE:** If a new processor is installed, you will receive a new thermal-cooling assembly, which will include an affixed thermal pad, or you will receive a new thermal pad along with a tech sheet to illustrate proper installation.

1. Align the pin-1 corner of the processor module with the pin-1 corner of the ZIF socket, then insert the processor module.

**NOTE:** The pin-1 corner of the processor module has a triangle that aligns with the triangle on the pin-1 corner of the ZIF socket.

When the processor module is properly seated, all four corners are aligned at the same height. If one or more corners of the module are higher than the others, the module is not seated properly.



1	ZIF-socket cam screw	2	ZIF socket
3	pin-1 corner		

➡ **NOTICE:** To avoid damage to the processor, hold the screwdriver so that it is perpendicular to the processor when turning the cam screw.

2. Tighten the ZIF socket by turning the cam screw clockwise to secure the processor module to the system board.
3. Replace the processor thermal-cooling assembly (see [Replacing the Processor Thermal-Cooling Assembly](#)).

---

[Back to Contents Page](#)

## Processor Thermal-Cooling Assembly

Dell™ Inspiron™ 1525/1526 Service Manual

### Removing the Processor Thermal-Cooling Assembly

**⚠ CAUTION:** Before you begin the following procedure, follow the safety instructions in the *Product Information Guide*.

1. Follow the instructions in [Before You Begin](#).
2. Turn the computer over.
3. Remove the eight captive screws securing the back cover and remove the module cover.

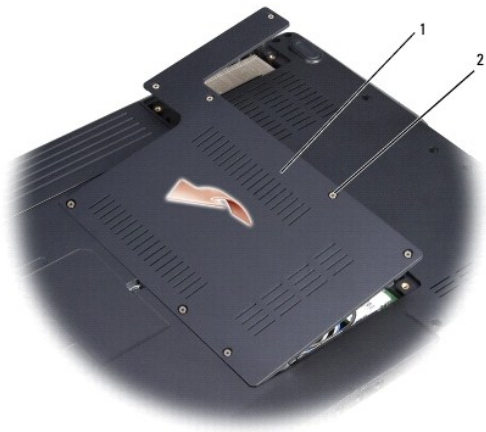

1	module cover	2	captive screws (8)
---	--------------	---	--------------------

4. In sequential order, loosen the five captive screws securing the processor thermal-cooling assembly to the system board, then carefully lift the processor thermal-cooling assembly out of the computer.

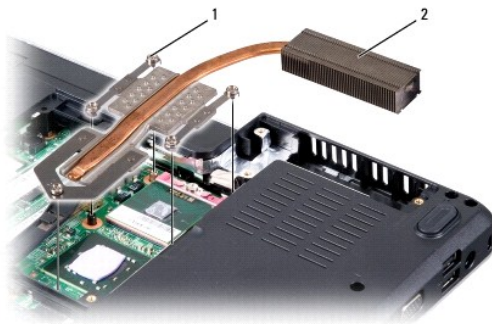

1	captive screws (5)	2	processor thermal-cooling assembly
---	--------------------	---	------------------------------------

### Replacing the Processor Thermal-Cooling Assembly

 **CAUTION:** Before you begin the following procedure, follow the safety instructions in the *Product Information Guide*.

1. Align the five captive screws on the processor thermal-cooling assembly with the screw holes on the system board.
2. In sequential order, tighten the five captive screws to secure the processor thermal-cooling assembly to the system board.
3. Replace the module cover and tighten the eight captive screws.

---

[Back to Contents Page](#)



## Display

### Dell™ Inspiron™ 1525/1526 Service Manual

- [Display Assembly](#)
- [Display Bezel](#)
- [Display Panel](#)
- [Camera and Microphone Assembly](#)

---

## Display Assembly

### Removing the Display Assembly

**⚠ CAUTION:** Before you begin the following procedure, follow the safety instructions in the *Product Information Guide*.

1. Follow the instructions in [Before You Begin](#).
2. Loosen the eight captive screws on the back cover and remove the cover.
3. Disconnect the antenna cables from the mini cards.
4. Lift the antenna cables from the securing tabs and release them from the routing channel.

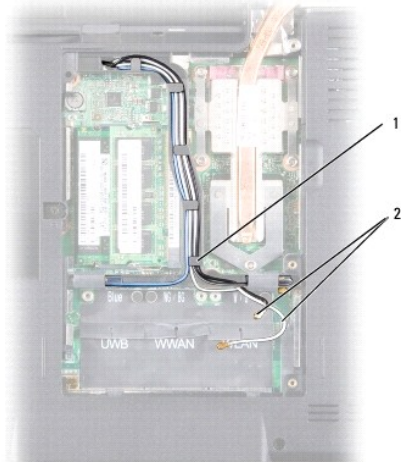

1	securing tabs	2	antenna cables
---	---------------	---	----------------

5. Remove the two screws securing the display assembly from the bottom of the computer.



6. Remove the center control cover (see [Removing the Center Control Cover](#)).
7. Remove the keyboard (see [Removing the Keyboard](#)).

8. Disconnect the display cable from the connector.
9. Disconnect the camera cable from the connector.

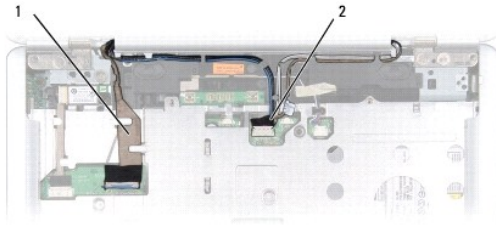

1	display cable	2	camera cable
---	---------------	---	--------------

10. Pull the antenna cables from the routing hole and release them from the routing channel.
11. Remove the four screws from the display assembly hinges.

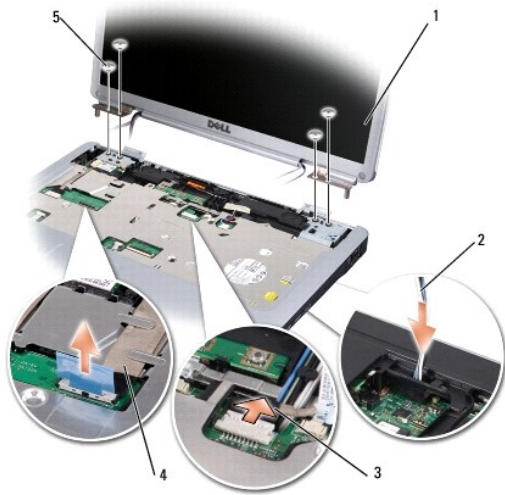

1	display assembly	2	antenna cables
3	camera cable	4	display cable
5	Hinge screws (4)		

12. Lift the display assembly out of the computer.

## Replacing the Display Assembly

**⚠ CAUTION:** Before you begin the following procedure, follow the safety instructions in the *Product Information Guide*.

1. Follow the instructions in [Before You Begin](#).
2. Align the display hinges with the holes in the base of the computer, then lower the display into place.
3. Replace and tighten the four display assembly hinge screws.
4. Slide the antenna cables through the routing hole to the base of the computer.
5. Replace the display cable, camera cable and antenna cables in their proper routing guides.

**NOTE:** Ensure that the display cable, camera cable, and antenna cables are properly routed and secured beneath the plastic tabs.

6. Connect the display cable to the display cable connector on the system board.
7. Connect the camera cables to the camera cable connector on the system board.
8. Replace the keyboard (see [Replacing the Keyboard](#)).
9. Replace the center control cover (see [Replacing the Center Control Cover](#)).
10. Close the display and turn the computer over.
11. Replace and tighten the two screws securing the display assembly from the bottom of the computer.
12. Connect the antennae cables to the Mini-Cards (see [Wireless Mini-Cards](#)).
13. Replace the back cover and tighten the eight captive screws on the cover.

---

## Display Bezel

### Removing the Display Bezel

**CAUTION:** Before you begin the following procedure, follow the safety instructions in the *Product Information Guide*.

1. Follow the instructions in [Before You Begin](#).
2. Remove the center control cover (see [Removing the Center Control Cover](#)).
3. Remove the keyboard (see [Removing the Keyboard](#)).
4. Remove the display assembly (see [Removing the Display Assembly](#)).
5. Remove the six rubber display bumpers from around the display bezel.
6. Remove the captive screw and five shoulder screws from around the display bezel.

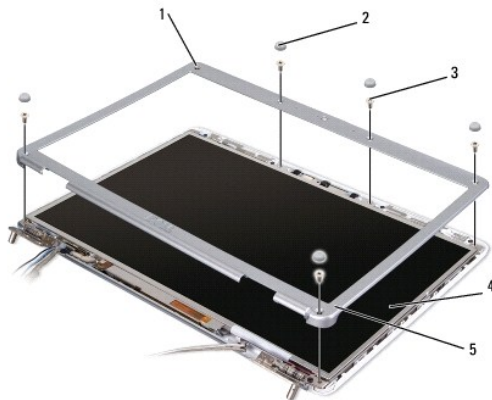

1	captive screw	2	rubber display bumpers (6)
3	shoulder screws (5)	4	display panel
5	display bezel		

**NOTICE:** Removal of the bezel from the display back cover requires extreme care to avoid damage to the bezel and the display panel.

7. Starting from the bottom corner of the display panel, use your fingers to pry the bezel from the top cover, then lift the inside edges to separate the

remainder of the bezel.

## Replacing the Display Bezel

**⚠ CAUTION:** Before you begin the following procedure, follow the safety instructions in the *Product Information Guide*.

1. Follow the instructions in [Before You Begin](#).
  2. Starting at any corner, use your fingers to gently snap the bezel into place to secure it to the display panel.
  3. Replace the captive screw and five shoulder screws around the display bezel.
  4. Replace the six rubber display bumpers around the display bezel.
  5. Replace the display assembly (see [Replacing the Display Assembly](#)).
  6. Replace the keyboard (see [Replacing the Keyboard](#)).
  7. Replace the center control cover (see [Replacing the Center Control Cover](#)).
- 

## Display Panel

### Removing the Display Panel

**⚠ CAUTION:** Before you begin the following procedure, follow the safety instructions in the *Product Information Guide*.

1. Follow the instructions in [Before You Begin](#).
2. Remove the center control cover (see [Removing the Center Control Cover](#)).
3. Remove the keyboard (see [Removing the Keyboard](#)).
4. Remove the display assembly (see [Removing the Display Assembly](#)).
5. Remove the display bezel (see [Removing the Display Bezel](#)).
6. Remove the two screws securing the display panel to the cover.

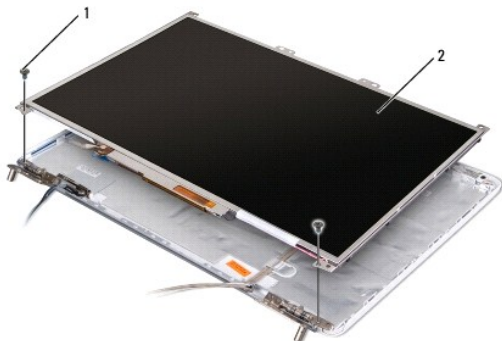

1	screws (2)	2	display panel
---	------------	---	---------------

7. Lift the display panel out of the display cover.
8. Remove the eight screws (four on each side of the display panel) securing the two brackets to the display panel and remove the brackets.

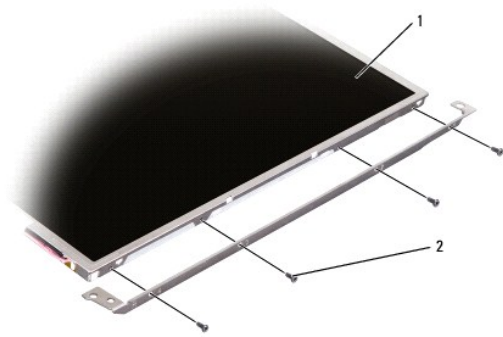

1	display panel	2	screws (8)
---	---------------	---	------------

9. Use the pull tab to disconnect the bottom flex-cable connector from the inverter connector.

10. Lift the tape securing the top flex-cable connector and gently pull to disconnect the top flex-cable connector from the display locking connector.

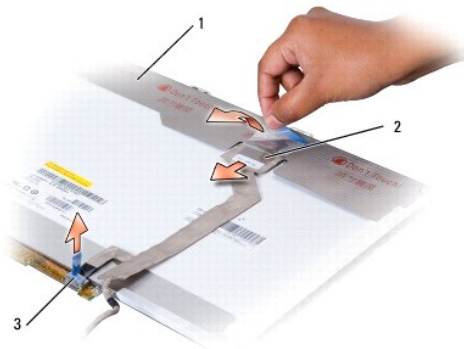

1	display panel	2	top flex-cable connector
3	bottom flex-cable connector		

## Replacing the Display Panel

**⚠ CAUTION:** Before you begin the following procedure, follow the safety instructions in the *Product Information Guide*.

1. Follow the instructions in [Before You Begin](#).
2. Connect the top flex-cable connector to the display connector.
3. Connect the bottom flex-cable connector to the inverter connector.
4. Align the screw holes on the display panel with the corresponding screw holes and guide pins on the top cover.
5. Gently lower the display panel into place and replace the two screws that secure the display panel to the cover.
6. Replace the eight screws (four on each side of the display panel) to secure the display brackets to the display panel.
7. Replace the display bezel (see [Replacing the Display Bezel](#)).
8. Replace the display assembly (see [Replacing the Display Assembly](#)).
9. Replace the keyboard (see [Replacing the Keyboard](#)).

10. Replace the center control cover (see [Replacing the Center Control Cover](#)).
- 

## Camera and Microphone Assembly

### Removing the Camera and Microphone Assembly

**⚠ CAUTION:** Before you begin the following procedure, follow the safety instructions in the *Product Information Guide*.

1. Follow the instructions in [Before You Begin](#).
2. Remove the center control cover (see [Removing the Center Control Cover](#)).
3. Remove the keyboard (see [Removing the Keyboard](#)).
4. Remove the display assembly (see [Removing the Display Assembly](#)).
5. Remove the display bezel (see [Removing the Display Bezel](#)).
6. Remove the display panel (see [Removing the Display Panel](#)).
7. Disconnect the camera cable connector from the camera and microphone assembly.
8. Lift the camera and microphone assembly out of the display cover.

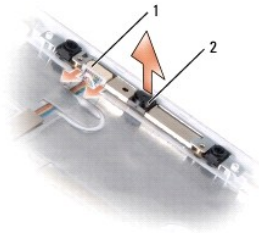

1	camera cable connector	2	camera/microphone assembly
---	------------------------	---	----------------------------

### Replacing the Camera and Microphone Assembly

**⚠ CAUTION:** Before you begin the following procedure, follow the safety instructions in the *Product Information Guide*.

1. Follow the instructions in [Before You Begin](#).
  2. Place the camera/microphone assembly on the display cover.
  3. Connect the camera cable connector to the camera/microphone assembly.
- 

[Back to Contents Page](#)

## ExpressCard Cage

Dell™ Inspiron™ 1525/1526 Service Manual

### Removing the ExpressCard Cage

**⚠ CAUTION:** Before you begin the following procedure, follow the safety instructions in the *Product Information Guide*.

1. Follow the instructions in [Before You Begin](#).
2. Remove the center control cover (see [Removing the Center Control Cover](#)).
3. Remove the keyboard (see [Removing the Keyboard](#)).
4. Remove the display assembly (see [Removing the Display Assembly](#)).
5. Remove the speakers (see [Removing the Speaker Assembly](#)).
6. Remove the palm rest (see [Removing the Palm Rest](#)).
7. Remove the three screws securing the ExpressCard cage to the computer base.
8. Lift the ExpressCard cage gently out of its system board connector and remove it.

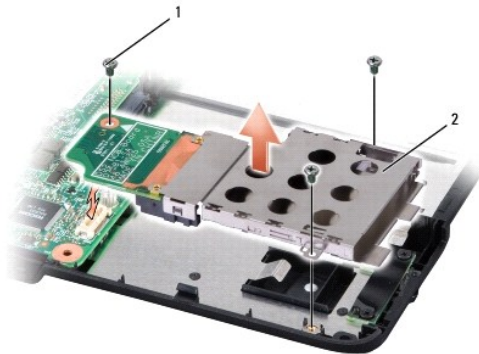

1	screws (3)	2	ExpressCard cage
---	------------	---	------------------

### Replacing the ExpressCard Cage

1. Replace the three screws securing the ExpressCard cage.
2. Connect the ExpressCard cable connector to the system board.
3. Replace the palm rest (see [Replacing the Palm Rest](#)).
4. Replace the speakers (see [Replacing the Speaker Assembly](#)).
5. Replace the display assembly (see [Replacing the Display Assembly](#)).
6. Replace the keyboard (see [Replacing the Keyboard](#)).
7. Replace the center control cover (see [Replacing the Center Control Cover](#)).







## Hard Drive

### Dell™ Inspiron™ 1525/1526 Service Manual

 **NOTE:** Dell does not guarantee compatibility or provide support for hard drives obtained from sources other than Dell.

 **CAUTION:** Before you begin any of the procedures in this section, follow the safety instructions in the *Product Information Guide*.

 **CAUTION:** Do not touch the metal housing of the hard drive if you remove the hard drive from the computer while the drive is hot.

 **NOTICE:** To prevent data loss, turn off your computer before removing the hard drive. Do not remove the hard drive while the computer is on or in Sleep state.

 **NOTICE:** Hard drives are extremely fragile. Exercise care when handling the hard drive.

## Removing the Hard Drive

1. Follow the procedures in [Before You Begin](#).
2. Turn the computer over and remove the two hard drive screws.

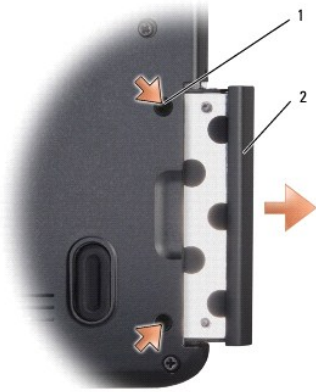

1	screws (2)	2	hard drive
---	------------	---	------------

 **NOTICE:** When the hard drive is not in the computer, store it in protective antistatic packaging (see "Protecting Against Electrostatic Discharge" in the *Product Information Guide*).

3. Slide the hard drive out of the computer.
4. Remove the two screws (one from each side of the hard drive cover), then pull to separate the cover from the hard drive.

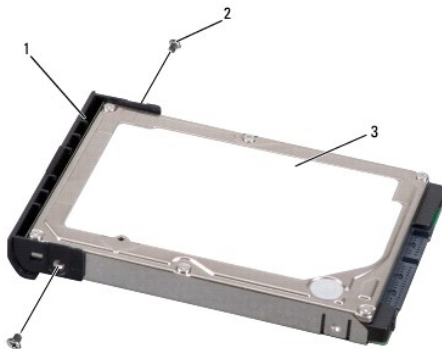

1	hard drive cover	2	screws (2)
3	hard drive		

## Replacing the Hard Drive

 **CAUTION:** Before you begin any of the procedures in this section, follow the safety instructions in the *Product Information Guide*.

 **NOTICE:** Hard drives are extremely fragile. Exercise care when handling the hard drive.

1. Replace the hard drive cover and tighten the two screws to secure the cover to the hard drive.

 **NOTICE:** Use firm and even pressure to slide the hard drive into place. Excessive force may result in damage to the connector.

2. Slide the hard drive into the hard drive bay until the drive is fully seated.
3. Replace the two screws to secure the hard drive.
4. Install the operating system for your computer, as needed (see "Restoring Your Operating System" in your *Owner's Manual*).
5. Install the drivers and utilities for your computer, as needed (see "Reinstalling Drivers and Utilities" in your *Owner's Manual*).

---

[Back to Contents Page](#)

## Keyboard

### Dell™ Inspiron™ 1525/1526 Service Manual

**⚠ CAUTION:** Before you begin any of the procedures in this section, follow the safety instructions in the **Product Information Guide**.

**👉 NOTICE:** To avoid electrostatic discharge, ground yourself by using a wrist grounding strap or by periodically touching an unpainted metal surface (such as a connector on the back of the computer).

**👉 NOTICE:** To help prevent damage to the system board, you must remove the battery from the battery bay before you begin working inside the computer.

## Removing the Keyboard

1. Follow the procedures in [Before You Begin](#).
2. Remove the center control cover (see [Removing the Center Control Cover](#)).
3. Remove the two screws at the top of the keyboard.

**👉 NOTICE:** The key caps on the keyboard are fragile, easily dislodged, and time-consuming to replace. Be careful when removing and handling the keyboard.

4. Lift the keyboard and hold it up and slightly forward to access to the keyboard connector.
5. To disconnect the keyboard cable from the keyboard connector on the system board, rotate the keyboard connector latch toward the front of the computer.
6. Slide the keyboard cable out of the keyboard connector.



1	screws (2)	2	keyboard
3	keyboard tabs (5)	4	keyboard cable
5	keyboard connector latch		

## Replacing the Keyboard

1. Slide the keyboard cable into the keyboard connector.
2. Rotate the keyboard connector latch to secure the cable.
3. Align the tabs along the bottom of the keyboard and slide them under the palm rest.
4. Press on the right edge near the top to snap the keyboard into place.
5. Replace the two screws on the top of the keyboard.



## Battery Latch Assembly

Dell™ Inspiron™ 1525/1526 Service Manual

- [Removing the Battery Latch Assembly](#)
  - [Replacing the Battery Latch Assembly](#)
- 

### Removing the Battery Latch Assembly

 **CAUTION:** Before you begin the following procedure, follow the safety instructions in the *Product Information Guide*.

1. Follow the instructions in [Before You Begin](#).
2. Remove all memory module (see [Removing Memory Module](#)).
3. Remove the hard drive (see [Removing the Hard Drive](#)).
4. Remove the optical drive (see [Removing the Optical Drive](#)).
5. Remove all Mini-Cards (see [Removing Mini-Card](#)).
6. Remove the center control cover (see [Removing the Center Control Cover](#)).
7. Remove the keyboard (see [Removing the Keyboard](#)).
8. Remove the display assembly (see [Removing the Display Assembly](#)).
9. Remove the internal card with Bluetooth wireless technology, if installed (see [Removing the Internal Card With Bluetooth® Wireless Technology](#)).
10. Remove the palm rest (see [Removing the Palm Rest](#)).
11. Remove the ExpressCard cage (see [Removing the ExpressCard Cage](#)).
12. Remove the processor thermal-cooling assembly (see [Removing the Processor Thermal-Cooling Assembly](#)).
13. Remove the processor (see [Removing the Processor Module](#)).
14. Remove the system board (see [Removing the System Board Assembly](#)).
15. Squeeze the plastic grip together to release the latch button.
16. Carefully pry open the spring.
17. Slide the battery latch assembly to the right and remove it.

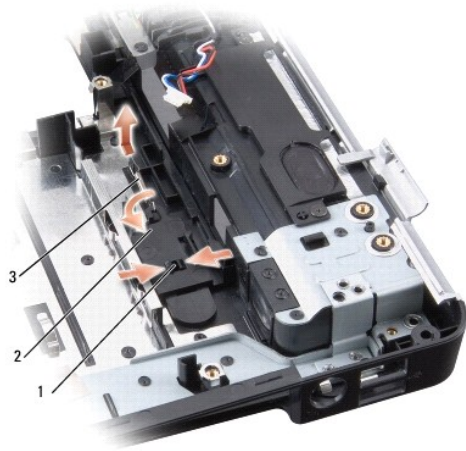

1	plastic grip	2	battery latch assembly
3	spring		

➡ **NOTICE:** Before you remove the battery release button, observe the orientation of the button to ensure proper installation when the button is replaced.

---

## Replacing the Battery Latch Assembly

⚠ **CAUTION:** Before you begin the following procedure, follow the safety instructions in the *Product Information Guide*.

➡ **NOTICE:** Ensure the battery latch assembly is properly oriented. The indent for the screw should face up when installing the assembly.

1. Slide the battery latch assembly into place.
  2. Replace the spring.
  3. Align the battery release button with the hole in the battery latch assembly, then press the button into place.
  4. Follow the steps in [Removing the Battery Latch Assembly](#) in the reverse order.
- 

[Back to Contents Page](#)

[Back to Contents Page](#)

## Memory

Dell™ Inspiron™ 1525/1526 Service Manual

**⚠ CAUTION:** Before you begin any of the procedures in this section, follow the safety instructions in the **Product Information Guide**.

You can increase your computer memory by installing memory modules on the system board. See "Specifications" in your Owner's Manual for information on the memory supported by your computer. Install only memory modules that are intended for your computer.

**🔧 NOTE:** Memory modules purchased from Dell are covered under your computer warranty.

Your computer has two user-accessible SODIMM sockets, DIMM A and DIMM B, accessed from the bottom of the computer.

**➡ NOTICE:** If you need to install memory modules in two connectors, install a memory module in the connector labeled "DIMMA" before you install a module in the connector labeled "DIMMB."

### Removing Memory Module

The memory modules are located under the memory module cover on the bottom of the computer.

1. Follow the procedures in [Before You Begin](#).
2. Turn the computer upside-down, loosen the eight captive screws on the cover and remove the cover.

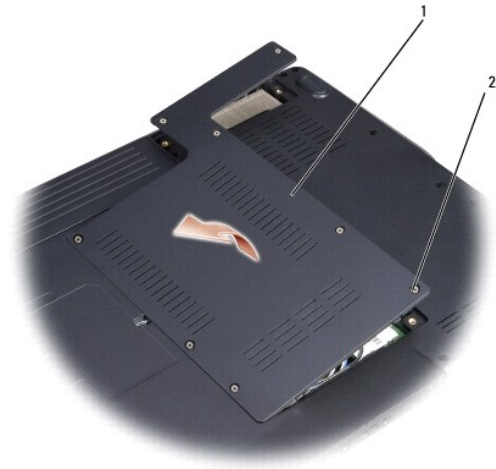

1	cover	2	captive screws (8)
---	-------	---	--------------------

**➡ NOTICE:** To prevent damage to the memory module connector, do not use tools to spread the memory module securing clips.

**➡ NOTICE:** To avoid electrostatic discharge, ground yourself by using a wrist grounding strap or by periodically touching an unpainted metal surface (such as a connector on the back of the computer).

3. Use your fingertips to carefully spread apart the securing clips on each end of the memory module connector until the module pops up.
4. Remove the module from the connector.

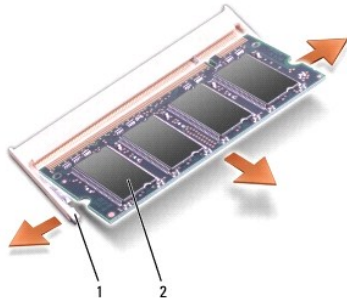

1	securing clips (2)	2	memory module
---	--------------------	---	---------------

## Replacing Memory Module

➡ **NOTICE:** To avoid electrostatic discharge, ground yourself by using a wrist grounding strap or by periodically touching an unpainted metal surface (such as a connector on the back of the computer).

1. Align the notch in the module edge connector with the tab in the connector slot.
2. Slide the module firmly into the slot at a 45-degree angle, and rotate the module down until it clicks into place. If you do not feel the click, remove the module and reinstall it.

🔍 **NOTE:** If the memory module is not installed properly, the computer may not boot. No error message indicates this failure.

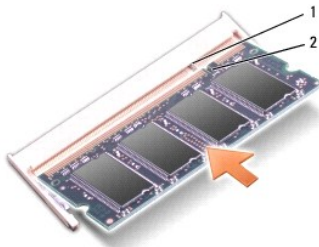

1	tab	2	notch
---	-----	---	-------

➡ **NOTICE:** If the cover is difficult to close, remove the module and reinstall it. Forcing the cover to close may damage your computer.

3. Replace the memory module cover.
4. Insert the battery into the battery bay, or connect the AC adapter to your computer and an electrical outlet.
5. Turn on the computer.

As the computer boots, it detects the additional memory and automatically updates the system configuration information.

To confirm the amount of memory installed in the computer, click **Start** → **Help and Support** → **Dell System Information**.

[Back to Contents Page](#)



[Back to Contents Page](#)

## Wireless Mini-Cards

Dell™ Inspiron™ 1525/1526 Service Manual

[Flash Cache Module](#)

**CAUTION:** Before you begin any of the procedures in this section, follow the safety instructions in the **Product Information Guide**.

**NOTICE:** To help prevent damage to the system board, you must remove the battery from the battery bay before you begin working inside the computer.

If you ordered a wireless Mini-Card with your computer, the card is already installed. Your computer supports three types of wireless Mini-Cards:

- 1 Wireless Local Area Network (WLAN)
- 1 Ultra-Wideband (UWB) card
- 1 Mobile Broadband or Wireless Wide Area Network (WWAN)

### Removing Mini-Card

1. Follow the procedures in [Before You Begin](#).
2. Turn the computer over.
3. Loosen the eight captive screws securing the back and remove the cover.



1	cover	2	captive screws (8)
---	-------	---	--------------------

4. Disconnect the antenna cables from the Mini-card.

**NOTE:** The Mini-card may have two or three connectors, depending on the type of card you ordered.

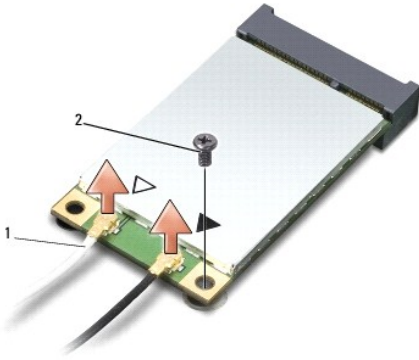

1	antenna cable connectors	2	securing screw
---	--------------------------	---	----------------

- Release the Mini-card by removing the securing screw.
- Lift the card out of its system board connector.

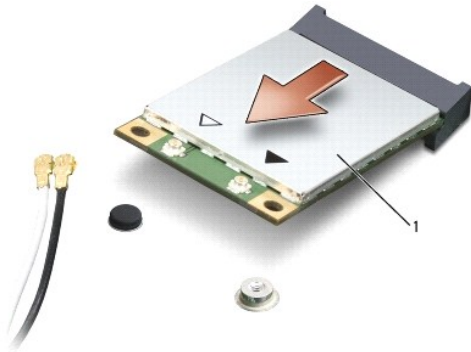

1	Mini-card
---	-----------

## Replacing Mini-Card

- ➔ **NOTICE:** The connectors are keyed to ensure correct insertion. If you feel resistance, check the connectors on the card and on the system board, and realign the card.
- ➔ **NOTICE:** To avoid damage to the Mini-card, never place cables under the card.

- Insert the card connector into the system board connector at a 45-degree angle.
- Press the other end of the card down into the slot on the system board until the card clicks into place.
- Replace the securing screw.
- Connect the cables to the Mini-Card, ensuring that you route the cables correctly.

📄 **NOTE:** For more specific information about which cable to connect to which connector, see the documentation that came with your Mini Card.

- Secure unused antenna cables in the protective mylar sleeve.
- Replace the cover and tighten the eight captive screws.

## Flash Cache Module

### Removing the FCM

1. Follow the procedures in [Before You Begin](#).
2. Turn the computer over and remove the cover on the Mini Card compartment.
3. Ground yourself by touching one of the metal connectors on the back of the computer.

 **NOTE:** If you leave the area, ground yourself again when you return to the computer.

4. Remove the M2 x 3-mm securing screw.
5. Lift the FCM out of its system board connector.

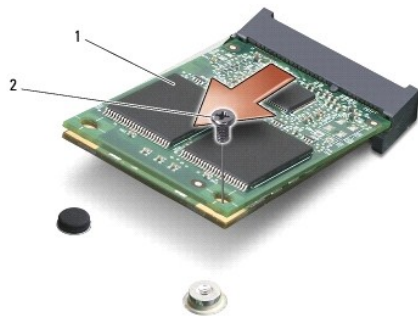

1	FCM Card	2	M2 x 3-mm securing screw
---	----------	---	--------------------------

### Replacing the FCM

 **NOTICE:** Install the FCM in the WWAN slot. Do not install an FCM in the WLAN card slot. Doing so may cause damage to your computer.

1. Insert the FCM connector at a 45-degree angle into the system board connector labeled "FCM".
2. Press the other end of the FCM down into the slot on the system board until the card clicks into place.
3. Replace the M2 x 3-mm securing screw.

---

[Back to Contents Page](#)

## Optical Drive

### Dell™ Inspiron™ 1525/1526 Service Manual

#### Removing the Optical Drive

1. Follow the procedures in [Before You Begin](#).
2. Turn the computer over.
3. Remove the locking screw from the optical drive.
4. Using a plastic scribe or screw driver, push the notch to release the optical drive from the bay.
5. Slide the optical drive out of the bay.

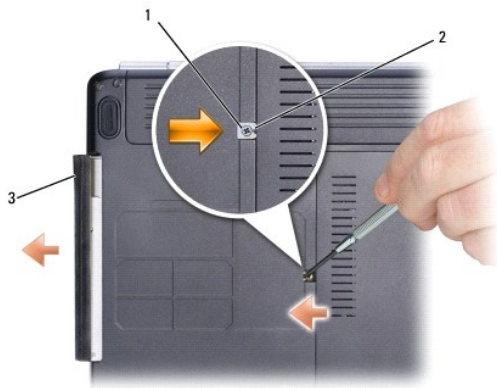

1	locking screw	2	notch	3	optical drive
---	---------------	---	-------	---	---------------

#### Replacing the Optical Drive

1. Slide the optical drive into the bay.
2. Replace and tighten the locking screw.

## Palm Rest

Dell™ Inspiron™ 1525/1526 Service Manual

### Removing the Palm Rest

**⚠ CAUTION:** Before you begin the following procedure, follow the safety instructions in the *Product Information Guide*.

1. Follow the instructions in [Before You Begin](#).
2. Remove the center control cover (see [Removing the Center Control Cover](#)).
3. Remove the keyboard (see [Removing the Keyboard](#)).
4. Remove the internal card with Bluetooth wireless technology, if installed (see [Removing the Internal Card With Bluetooth® Wireless Technology](#)).

**🔧 NOTE:** It is not necessary to remove the Bluetooth cable connector from the system board connector.

5. Disconnect the button board cable from the system board.
6. Disconnect the speaker cable from the system board.
7. Remove the display assembly (see [Removing the Display Assembly](#)).
8. Remove the nine screws from the bottom of the computer.

**🔧 NOTE:** The screw locations may vary slightly from the image shown below.

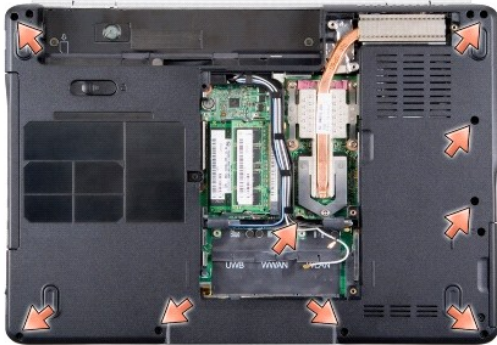

9. Turn the computer over and remove the two screws securing the top of the palm rest.
10. Disconnect the touch pad connector and the device status lights LED connector from the system board.

**➡ NOTICE:** Do not use force to separate the palm rest from the computer. If you encounter resistance, gently *flex* or apply pressure to the palm rest, or move along the edge, working away from the area of resistance, until the palm rest is free.

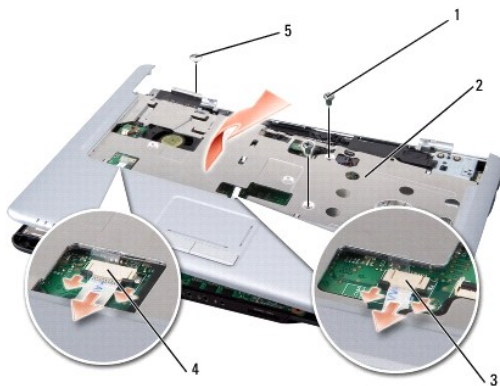

1	screws (2)	2	palm rest
3	touch pad connector	4	device status lights LED connector
5	display hinge screw		

11. Moving from left to right, carefully lift the palm rest along the rear edge, near the hinge brackets, then gently lift the palm rest to remove it from the computer.

## Replacing the Palm Rest

**⚠ CAUTION:** Before you begin the following procedure, follow the safety instructions in the *Product Information Guide*.

1. Align the palm rest with the base of the computer and gently snap it into place.
2. Connect the touch pad connector and the device status lights LED connector to the system board.
3. Replace the two screws on the top of the palm rest.
4. Turn the computer over and replace the nine screws on the bottom of the computer to secure the palm rest.

---

[Back to Contents Page](#)

## ExpressCards

Dell™ Inspiron™ 1525/1526 Service Manual

### Removing an ExpressCard or Blank

**⚠ CAUTION:** Before you begin any of the procedures in this section, follow the safety instructions in the *Product Information Guide*.

Press the card or blank to remove it from its slot.

Save a blank to use when no ExpressCard is installed in a slot. Blanks protect unused slots from dust and other particles.

### Installing an ExpressCard or Blank

**⚠ CAUTION:** Before you begin any of the procedures in this section, follow the safety instructions in the *Product Information Guide*.

You can install an ExpressCard while the computer is running. The computer automatically detects the card.

ExpressCards are generally marked with a symbol (such as a triangle or an arrow) or a label to indicate which end to insert into the slot. The cards are keyed to prevent incorrect insertion. If card orientation is not clear, see the documentation that came with the card.

To install an ExpressCard:

1. Hold the card with the top side of the card facing up.
2. Slide the card into the slot until the card is completely seated in its connector.

If you encounter too much resistance, do not force the card. Check the card orientation and try again.



The computer recognizes the ExpressCard and automatically loads the appropriate device driver. If the configuration program tells you to load the manufacturer's drivers, use the media that came with the ExpressCard.

## Pin Assignments for I/O Connectors

Dell™ Inspiron™ 1525/1526 Service Manual

- [USB Connector](#)
  - [Video Connector](#)
  - [S-Video TV-Out Connector](#)
  - [1394 Connector](#)
  - [HDMI Connector](#)
- 

### USB Connector

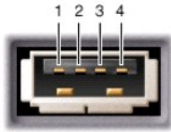

Pin	Signal
1	USB5V+
2	USBP-
3	USBP+
4	GND

---

### Video Connector



Pin	Signal	Pin	Signal
1	CRT_R	9	5V+
2	CRT_G	10	GND
3	CRT_B	11	MONITOR_DETECT-
4	NC	12	DDC_DATA
5	GND	13	CRT_HS
6	GND	14	CRT_VS
7	GND	15	DDC_CLK
8	GND		

---

### S-Video TV-Out Connector



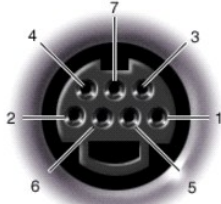

S-Video	
Pin	Signal
1	GND
2	GND
3	DLUMA-L
4	DCRMA-L

### 1394 Connector

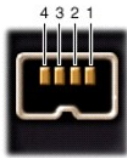

Pin	Signal
1	TPB-
2	TPB+
3	TPA-
4	TPA+

### HDMI Connector

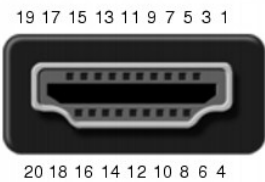

Pin	Signal	Pin	Signal
1	TMDS Data 2+	11	TMDS Clock Shield
2	TMDS Data 2 Shield	12	TMDS Clock-
3	TMDS Data 2-	13	CEC
4	TMDS Data 1+	14	No Connect
5	TMDS Data 1 Shield	15	DDC Clock
6	TMDS Data 1-	16	DDC Data
7	TMDS Data 0+	17	Ground
8	TMDS Data 0 Shield	18	+5V Power

9	TMDS Data 0-	19	Hot Plug Detect
10	TMDS Clock+	20	SHELL

---

[Back to Contents Page](#)

[Back to Contents Page](#)

## Subscriber Identity Module (Optional)

Dell™ Inspiron™ 1525/1526 Service Manual

Subscriber Identity Modules (SIM) identify users uniquely through an International Mobile Subscriber Identity.

### Replacing the SIM

**⚠ CAUTION:** Before you begin any of the procedures in this section, follow the safety instructions in the *Product Information Guide*.

**🔧 NOTE:** Only GSM (HSDPA) type cards need a SIM. EVDO cards do not use a SIM.

1. Follow the procedures in [Before You Begin](#).
2. In the battery bay, slide the SIM into the compartment with the cut-off corner of the card facing away from the compartment.



1	SIM	2	battery bay
---	-----	---	-------------

### Removing the SIM

Press the SIM into the slot to release it. When it is partially ejected, remove the SIM from the battery bay.

---

[Back to Contents Page](#)

## Speaker Assembly

Dell™ Inspiron™ 1525/1526 Service Manual

### Removing the Speaker Assembly

**⚠ CAUTION:** Before you begin the following procedure, follow the safety instructions in the *Product Information Guide*.

1. Follow the instructions in [Before You Begin](#).
2. Remove the center control cover (see [Removing the Center Control Cover](#)).
3. Remove the keyboard (see [Removing the Keyboard](#)).
4. Remove the display assembly (see [Removing the Display Assembly](#)).
5. Disconnect the speaker cable connector from the system board.
6. Remove the four screws securing the speaker assembly to the base of the computer.
7. Remove the speaker assembly.

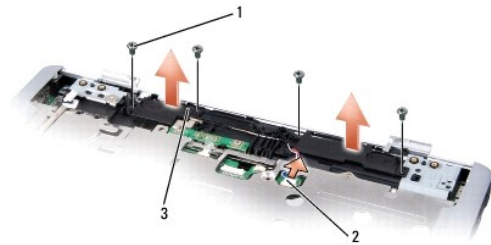

1	screws (4)	2	speaker cable connector
3	speaker assembly		

### Replacing the Speaker Assembly

**⚠ CAUTION:** Before you begin the following procedure, follow the safety instructions in the *Product Information Guide*.

1. Align the guide holds in the speaker assembly with the guide posts on the base of the computer, then lower the assembly into place.
2. Replace the four securing screws.
3. Route the speaker cables carefully through the routing channel.
4. Connect the speaker cable to the system board.
5. Replace the display assembly (see [Replacing the Display Assembly](#)).
6. Replace the keyboard (see [Replacing the Keyboard](#)).
7. Replace the center control cover (see [Replacing the Center Control Cover](#)).



[Back to Contents Page](#)

## System Board Assembly

Dell™ Inspiron™ 1525/1526 Service Manual

- [S-Video Board](#)
- [Charger Board](#)

The system board's BIOS chip contains the Service Tag, which is also visible on a barcode label on the bottom of the computer. The replacement kit for the system board includes media that provides a utility for transferring the Service Tag to the replacement system board.

### Removing the System Board Assembly

 **CAUTION:** Before you begin the following procedure, follow the safety instructions in the *Product Information Guide*.

1. Follow the instructions in [Before You Begin](#).
2. Remove memory module(s) (see [Removing Memory Module](#)).
3. Remove the hard drive (see [Removing the Hard Drive](#)).
4. Remove the optical drive (see [Removing the Optical Drive](#)).
5. Remove all Mini-Cards (see [Removing Mini-Card](#)).
6. Remove the center control cover (see [Removing the Center Control Cover](#)).
7. Remove the keyboard (see [Removing the Keyboard](#)).
8. Remove the display assembly (see [Removing the Display Assembly](#)).
9. Remove the internal card with Bluetooth wireless technology, if installed (see [Removing the Internal Card With Bluetooth® Wireless Technology](#)).
10. Remove the palm rest (see [Removing the Palm Rest](#)).
11. Remove the ExpressCard cage (see [Removing the ExpressCard Cage](#)).
12. Remove the processor thermal-cooling assembly (see [Removing the Processor Thermal-Cooling Assembly](#)).
13. Remove the processor (see [Removing the Processor Module](#)).
14. Disconnect the processor heat sink fan cable from the system board.
15. Disconnect the button board cable from the system board.
16. Disconnect the speaker cable from the system board.

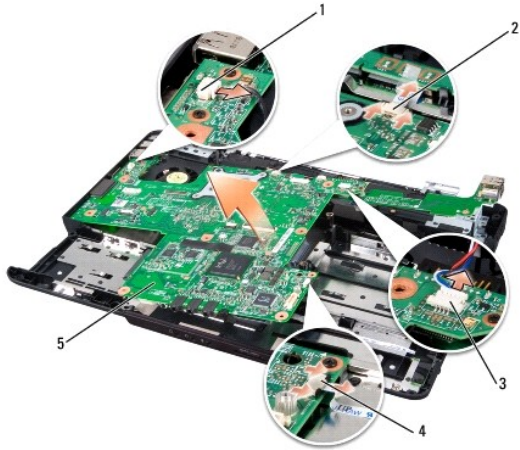

1	processor heat sink fan cable connector	2	button board cable connector
3	speaker cable connector	4	wireless sniffer board connector
5	system board		

17. Remove the four screws from the top of the system board.

**NOTE:** Depending on your system configuration, the number of screws shown may be greater than the number of screws present in your system.



18. Lift the right side of the system board, and then carefully lift the system board out of the computer.

## Replacing the System Board Assembly

**CAUTION:** Before you begin the following procedure, follow the safety instructions in the *Product Information Guide*.

**NOTICE:** Ensure that any loose cables do not get caught beneath the system board.

1. Insert the right side of the system board into the base of the computer at an angle until the connectors on the system board are aligned with the holes on the base of the computer, then carefully lower the system board into place.
2. Replace the four screws on the top of the system board.
3. Follow the steps in [Removing the System Board Assembly](#) in reverse order.

---

## S-Video Board

## Removing the S-Video Board

**⚠ CAUTION:** Before you begin the following procedure, follow the safety instructions in the *Product Information Guide*.

1. Follow the instructions in [Before You Begin](#).
2. Remove all memory modules (see [Removing Memory Module](#)).
3. Remove the hard drive (see [Removing the Hard Drive](#)).
4. Remove the optical drive (see [Removing the Optical Drive](#)).
5. Remove all Mini-Cards (see [Removing Mini-Card](#)).
6. Remove the center control cover (see [Removing the Center Control Cover](#)).
7. Remove the keyboard (see [Removing the Keyboard](#)).
8. Remove the display assembly (see [Removing the Display Assembly](#)).
9. Remove the internal card with Bluetooth wireless technology, if installed (see [Removing the Internal Card With Bluetooth® Wireless Technology](#)).
10. Remove the palm rest (see [Removing the Palm Rest](#)).
11. Remove the ExpressCard cage (see [Removing the ExpressCard Cage](#)).
12. Remove the processor thermal-cooling assembly (see [Removing the Processor Thermal-Cooling Assembly](#)).
13. Remove the processor (see [Removing the Processor Module](#)).
14. Remove the system board (see [Removing the System Board Assembly](#)).
15. Remove the screw securing the S-Video board to the system board assembly.
16. Carefully disconnect the S-Video connector from the system board and separate the S-Video board from the system board assembly.

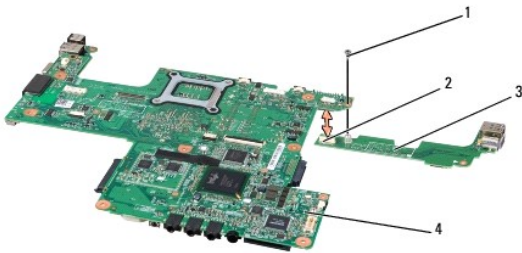

1	screw	2	S-Video connector
3	S-Video board	4	system board

## Replacing the S-Video Board

**⚠ CAUTION:** Before you begin the following procedure, follow the safety instructions in the *Product Information Guide*.

1. Align the S-Video board to the system board in the right direction and gently press to connect the S-Video connector to the system board.
2. Replace the screw securing the S-Video board to the system board assembly.
3. Follow the steps in [Removing the S-Video Board](#) in the reverse order.



---

## Charger Board

### Removing the Charger Board

**⚠ CAUTION:** Before you begin the following procedure, follow the safety instructions in the *Product Information Guide*.

1. Follow the instructions in [Before You Begin](#).
2. Remove all memory module (see [Removing Memory Module](#)).
3. Remove the hard drive (see [Removing the Hard Drive](#)).
4. Remove the optical drive (see [Removing the Optical Drive](#)).
5. Remove all Mini-Cards (see [Removing Mini-Card](#)).
6. Remove the center control cover (see [Removing the Center Control Cover](#)).
7. Remove the keyboard (see [Removing the Keyboard](#)).
8. Remove the display assembly (see [Removing the Display Assembly](#)).
9. Remove the internal card with Bluetooth wireless technology, if installed (see [Removing the Internal Card With Bluetooth® Wireless Technology](#)).
10. Remove the palm rest (see [Removing the Palm Rest](#)).
11. Remove the ExpressCard cage (see [Removing the ExpressCard Cage](#)).
12. Remove the processor thermal-cooling assembly (see [Removing the Processor Thermal-Cooling Assembly](#)).
13. Remove the processor (see [Removing the Processor Module](#)).
14. Remove the system board (see [Removing the System Board Assembly](#)).
15. Remove the two screws securing the charger board to the system board assembly.
16. Carefully disconnect the charger board connector from the system board and separate charger board from the system board assembly.

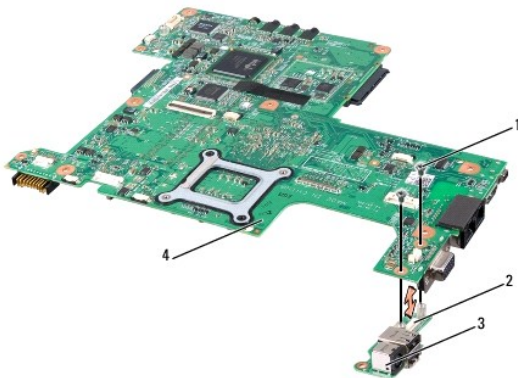

1	screws (2)	2	charger board connector
3	charger board	4	system board

## Replacing the Charger Board

 **CAUTION:** Before you begin the following procedure, follow the safety instructions in the *Product Information Guide*.

1. Align the charger board to the system board in the right direction and gently press to connect the charger board connector to the system board.
  2. Replace the two screws securing the charger board to the system board assembly.
  3. Follow the steps in [Removing the Charger Board](#) in the reverse order.
- 

[Back to Contents Page](#)

[Back to Contents Page](#)

## **Dell™ Inspiron™ 1525/1526 Service Manual**



**NOTE:** A NOTE indicates important information that helps you make better use of your computer.



**NOTICE:** A NOTICE indicates either potential damage to hardware or loss of data and tells you how to avoid the problem.



**CAUTION:** A CAUTION indicates potential for property damage, personal injury, or death.

Information in this document is subject to change without notice.  
© 2007–2008 Dell Inc. All rights reserved.

Reproduction in any manner whatsoever without the written permission of Dell Inc. is strictly forbidden.

Trademarks used in this text: *Dell*, the *DELL* logo, and *Inspiron* are trademarks of Dell Inc.; *Microsoft*, *Windows*, and *Windows Vista* are either trademarks or registered trademarks of Microsoft Corporation in the United States and/or other countries.

Other trademarks and trade names may be used in this document to refer to either the entities claiming the marks and names or their products. Dell Inc. disclaims any proprietary interest in trademarks and trade names other than its own.

January 2008 Rev. A00

---

[Back to Contents Page](#)